

### EL 5630 62-117D-W80650H-AM



### Features

- Package: Warm White LED with 5630 package
- Emitted Color: Warm White
- Typ. Luminance Intensity: 9100 mcd @ 65mA
- Typ. Luminous Flux: 27 lm @ 65mA
- Viewing angle: 120°
- ESD: up to 8KV
- MSL: 2
- Preconditioning: According to JEDEC J-STD 020D Level 2
- Qualifications: According to AEC-Q101
- Compliance with RoHS and REACH

### Applications

- Automotive Interior Lighting, Dashboard, Switch, Reading lamp, Audio and Car Infotainment, etc
- Backlight: LCD, switches, symbol, mobile phone and illuminated advertising.
- Optical indicator.
- General applications.

## Contents

<b>Characteristics</b> .....	3
<b>Absolute Maximum Ratings</b> .....	4
<b>Characteristics Graph</b> .....	5
<b>Binning Information</b> .....	10
<b>Part Number</b> .....	19
<b>Ordering Information</b> .....	20
<b>Mechanical Dimension</b> .....	21
<b>Recommended Soldering Pad</b> .....	22
<b>Reflow Soldering Profile</b> .....	22
<b>Packaging Information</b> .....	23
<b>Precaution for Use</b> .....	25

## 1. Characteristics

Parameter		Symbol	Min.	Typ.	Max.	Unit	Condition
Forward Current	Warm White	$I_F$	20	65	180	mA	---
Luminous Flux <sup>[1][2][3]</sup>	Warm White	$\Phi_v$	24	27	40	lm	$I_F=65\text{mA}$
Forward Voltage <sup>[4][5]</sup>	Warm White	$V_F$	2.5	2.9	3.5	V	$I_F=65\text{mA}$
Viewing Angle	Warm White	$\phi$	---	120	---	deg	$I_F=65\text{mA}$
Chromaticity coordinates <sup>[6]</sup>	Warm White	CIE x	---	0.4337	---	---	$I_F=65\text{mA}$
		CIE y	---	0.4019	---	---	$I_F=65\text{mA}$
Color Rendering Index	Warm White	Ra	80	---	---	---	$I_F=65\text{mA}$
Thermal Resistance (Junction to Solder)	Real	$R_{th JS real}$	---	30	---	K/W	$I_F=65\text{mA}$
	Electrical	$R_{th JS el}$	---	15	---		

### Notes:

1. Luminous Flux measurement tolerance:  $\pm 8\%$ .
2. The data of Luminous Flux measured at thermal pad= $25^\circ\text{C}$ .
3. Typical Luminous Flux or light output performance is operated within the condition guided by this datasheet.
4. Forward Voltage measurement tolerance:  $\pm 0.05\text{V}$ .
5. The  $V_F$  range shown in the table above indicates 99% output.
6. Tolerance of Chromaticity Coordinates x,y:  $\pm 0.005$ .

## 2. Absolute Maximum Ratings

Parameter	Symbol	Ratings	Unit
Power Dissipation	$P_d$	630	mW
Forward Current	$I_F$	20 ~ 180	mA
Surge Current	$I_{FM}$	1500	mA
Reverse Voltage	$V_R$	Not designed for reverse operation	V
Junction Temperature	$T_J$	125	°C
Operating Temperature	$T_{opr}$	-40 ~ +110	°C
Storage Temperature	$T_{stg}$	-40 ~ +110	°C
ESD Sensitivity (R=1.5kΩ, C= 100pF)	$ESD_{HBM}$	8	kV
Soldering Temperature	Reflow	260°C for 30sec	---

### 3. Characteristics Graph

#### Wavelength Characteristics Relative Spectral Distribution

@ Ts = 25°C, If = 65mA, RH = 30%

$$\Phi_V / \Phi_V (Max.) = f(\lambda)$$

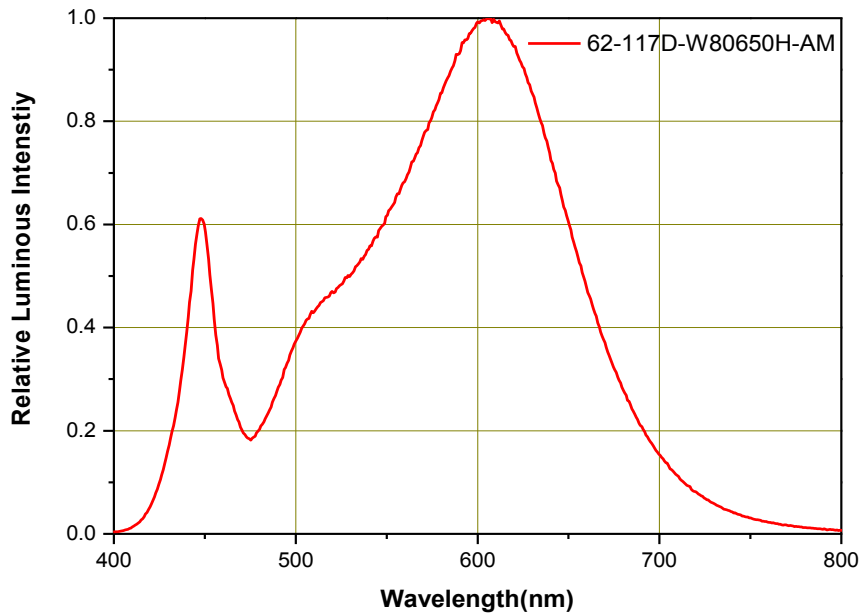

#### Typical Diagram Characteristics of Radiation

$$\Phi_V / \Phi_V (0^\circ) = f(\varphi)$$

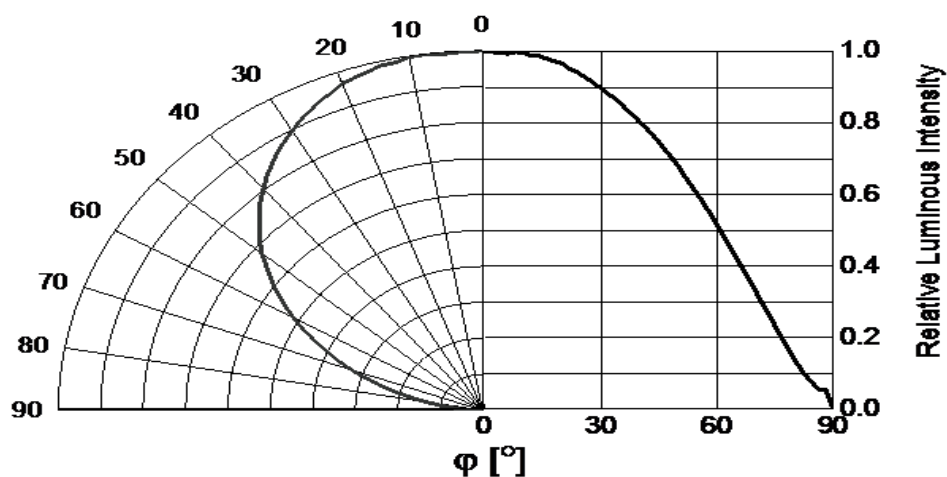

**Notes:**

1.  $\varphi$  is the off axis angle from lamp centerline where the luminous intensity is 1/2 of the peak value.

### Forward Current vs. Forward Voltage @ Ts = 25°C

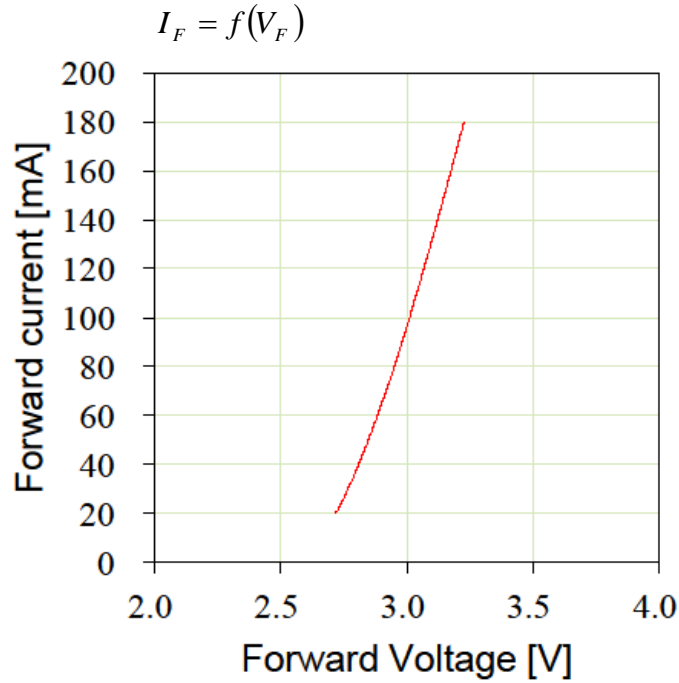

### Relative Luminous Flux vs. Forward Current @ Ts = 25°C

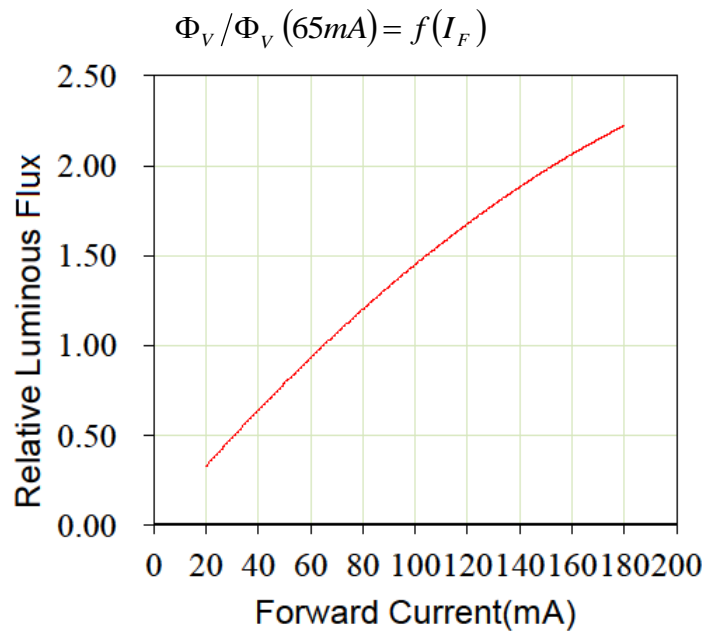

### Chromaticity Coordinates Shift vs. Forward Current @ $T_s = 25^\circ\text{C}$

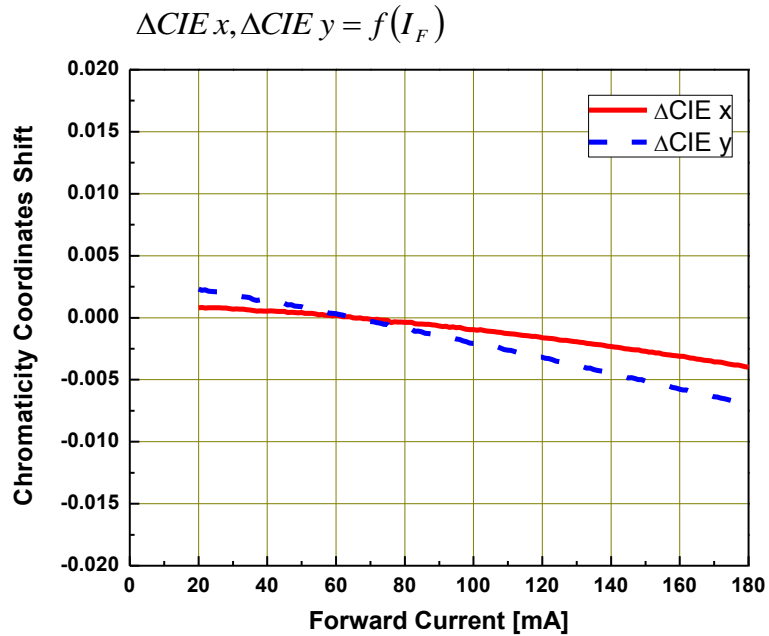

### Relative Forward Voltage vs. Junction Temperature @ $I_F = 65\text{mA}$

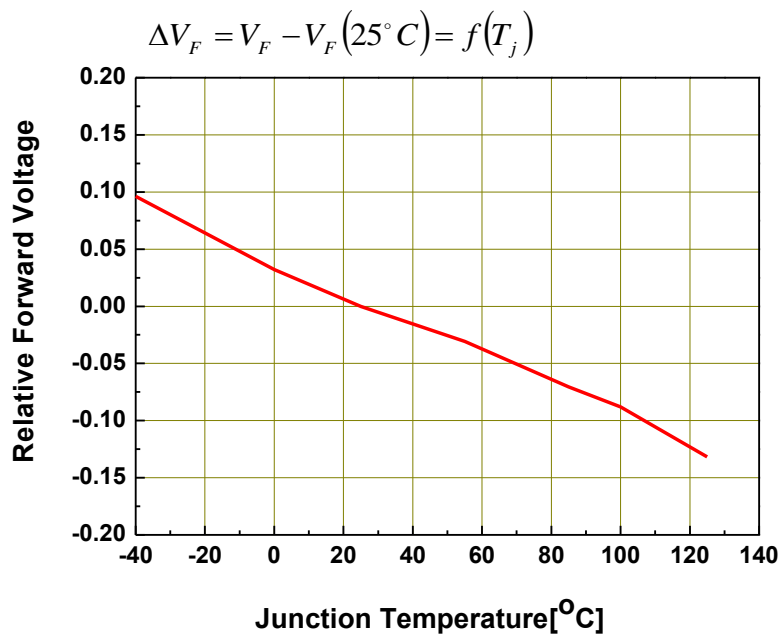

### Relative Luminous Flux vs. Junction Temperature

@  $I_F = 65\text{mA}$

$$\Phi_v / \Phi_v(25^\circ\text{C}) = f(T_j)$$

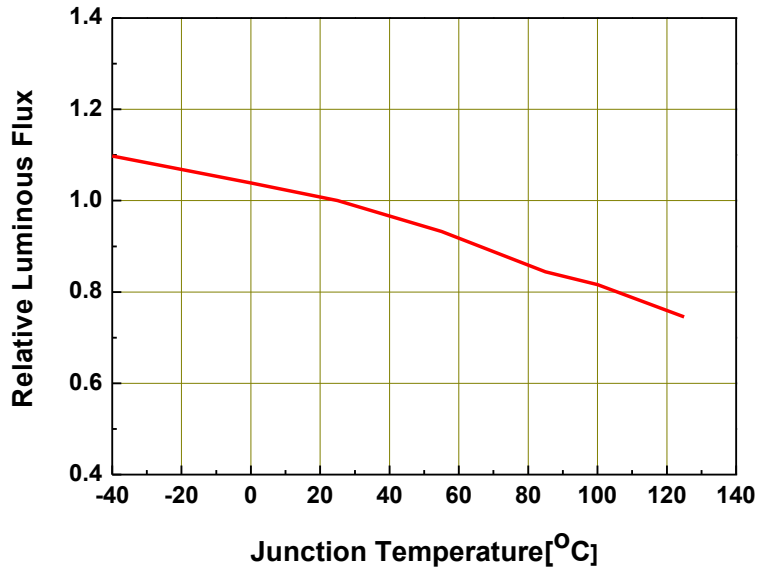

### Chromaticity Coordinates Shift vs. Junction Temperature

@  $I_F = 65\text{mA}$

$$\Delta CIE_x, \Delta CIE_y = f(T_j)$$

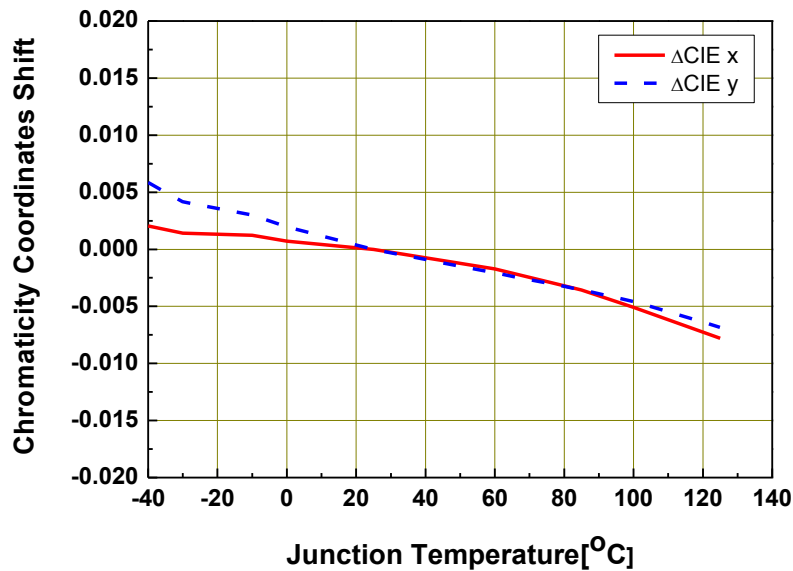



### Forward Current Derating Curve

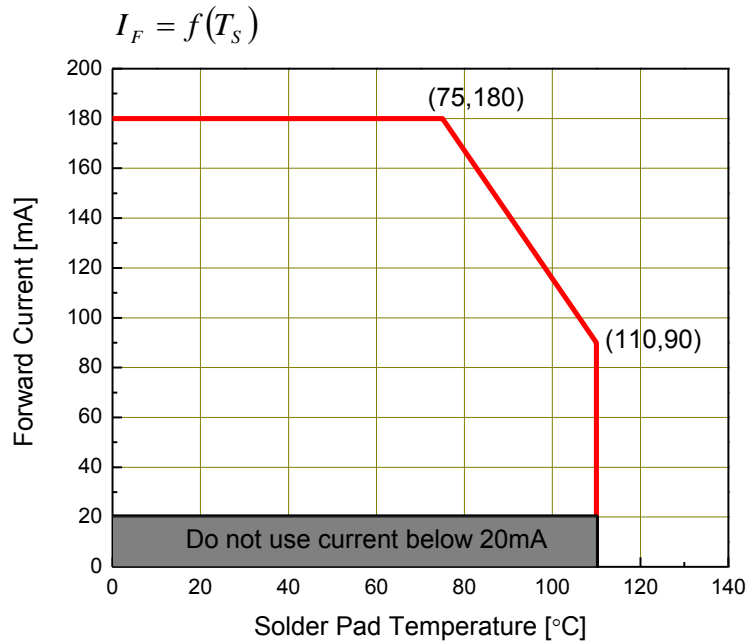

### Permissible Pulse Handling Capability

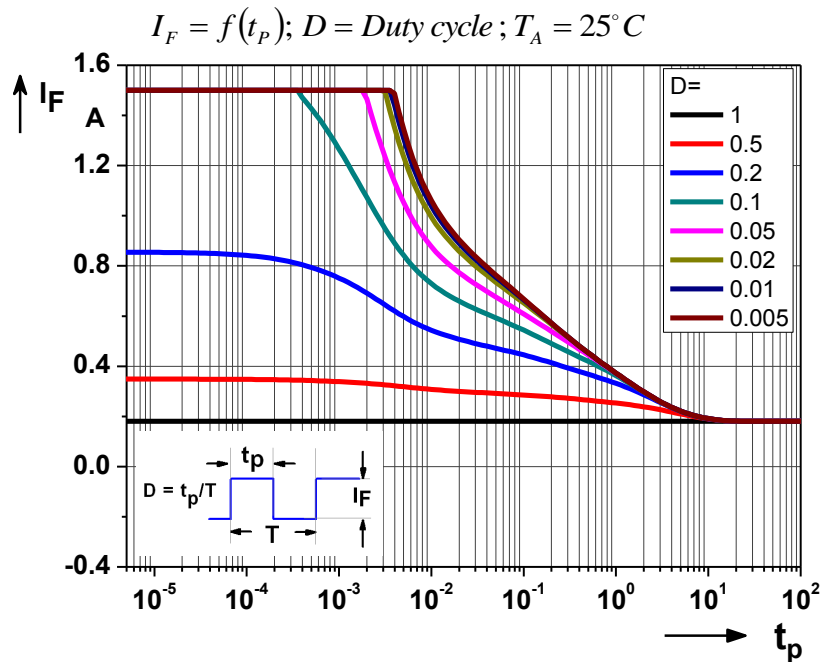

## 4. Binning Information

### Luminous Flux and Intensity Bins

Group Bin	Minimum Luminous Flux (lm)	Maximum Luminous Flux (lm)	Minimum Luminous Intensity (mcd)	Maximum Luminous Intensity (mcd)
Z1	1	3	330	990
Z3	3	5	990	1650
Z5	5	7	1650	2310
Z7	7	9	2310	2970
Z9	9	12	2970	3960
A2	12	15	3960	4950
A5	15	18	4950	5940
A8	18	21	5940	6930
B1	21	24	6930	7920
B4	24	27	7920	8910
B7	27	30	8910	9900
C0	30	35	9900	11550
C5	35	40	11550	13200
D0	40	45	13200	14850
D5	45	50	14850	16500
E0	50	55	16500	18150
E5	55	60	18150	19800

**Notes:**

1. Luminous Flux measurement tolerance:  $\pm 8\%$ .
2. Highlighted Black Box is available bins.
3. The Luminous Flux table is only for reference.

### Color Bin Structure

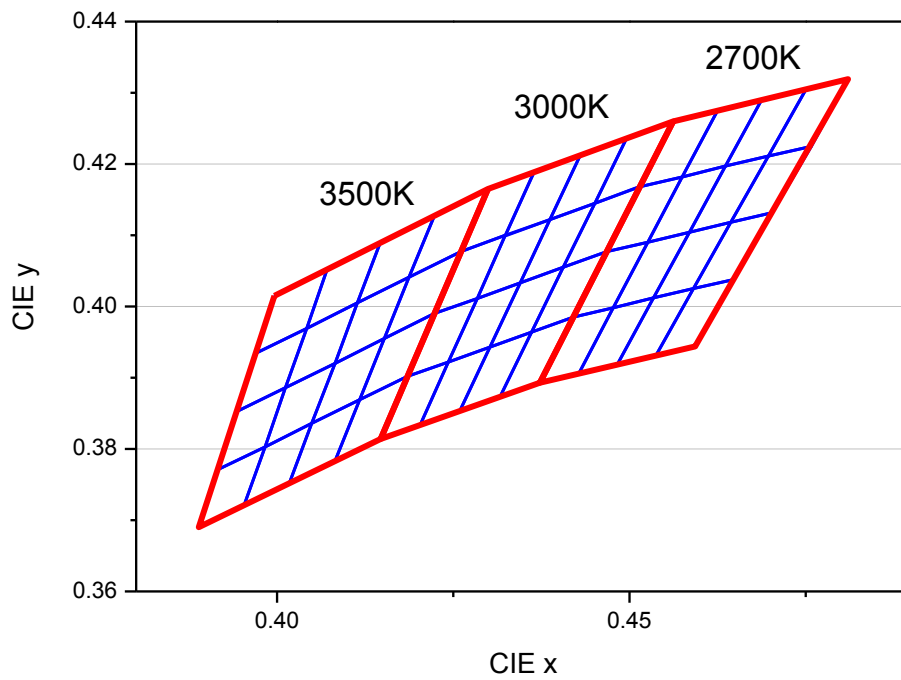

**Notes:**

1. Tolerance of Chromaticity Coordinates x,y:  $\pm 0.005$ .

### Color Bin Structure

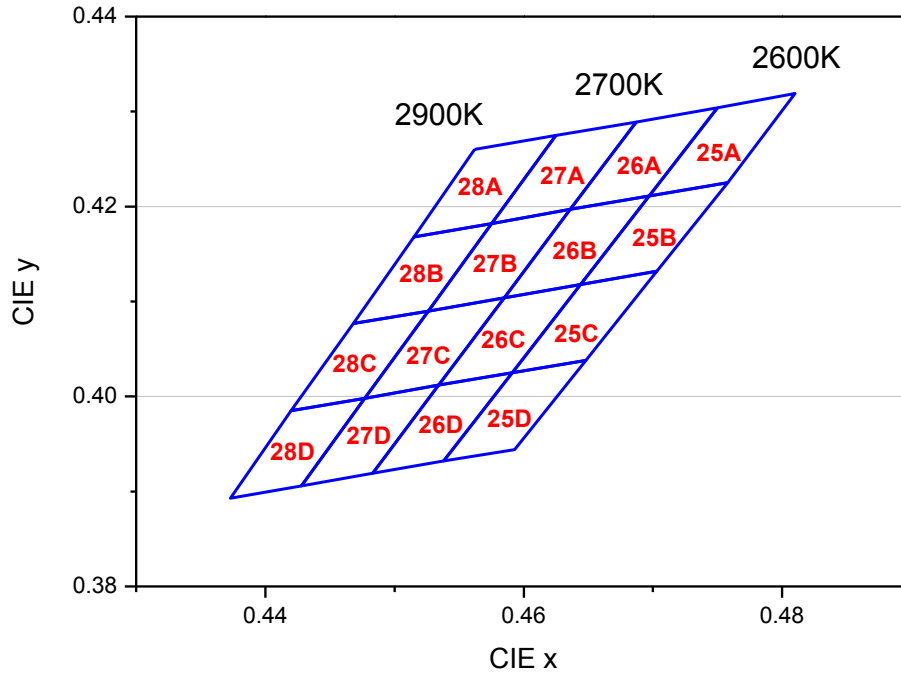

### Color Bin Coordinates

CCT	Bin Code	CIE_x	CIE_y	Bin Code	CIE_x	CIE_y
2700K	25A	0.4750	0.4304	25B	0.4697	0.4211
		0.4697	0.4211		0.4644	0.4118
		0.4758	0.4225		0.4703	0.4132
		0.4810	0.4319		0.4758	0.4225
	25C	0.4644	0.4118	25D	0.4591	0.4025
		0.4591	0.4025		0.4538	0.3932
		0.4648	0.4038		0.4593	0.3944
		0.4703	0.4132		0.4648	0.4038
	26A	0.4687	0.4289	26B	0.4636	0.4197
		0.4636	0.4197		0.4585	0.4104
		0.4697	0.4211		0.4644	0.4118
		0.4750	0.4304		0.4697	0.4211
	26C	0.4585	0.4104	26D	0.4534	0.4012
		0.4534	0.4012		0.4483	0.3919
		0.4591	0.4025		0.4538	0.3932
		0.4644	0.4118		0.4591	0.4025

CCT	Bin Code	CIE_x	CIE_y	Bin Code	CIE_x	CIE_y
2700K	27A	0.4625	0.4275	27B	0.4575	0.4182
		0.4575	0.4182		0.4526	0.4090
		0.4636	0.4197		0.4585	0.4104
		0.4687	0.4289		0.4636	0.4197
	27C	0.4526	0.4090	27D	0.4477	0.3998
		0.4477	0.3998		0.4428	0.3906
		0.4534	0.4012		0.4483	0.3919
		0.4585	0.4104		0.4534	0.4012
	28A	0.4562	0.4260	28B	0.4515	0.4168
		0.4515	0.4168		0.4468	0.4077
		0.4575	0.4182		0.4526	0.4090
		0.4625	0.4275		0.4575	0.4182
	28C	0.4468	0.4077	28D	0.4420	0.3985
		0.4420	0.3985		0.4373	0.3893
		0.4477	0.3998		0.4428	0.3906
		0.4526	0.4090		0.4477	0.3998

### Color Bin Structure

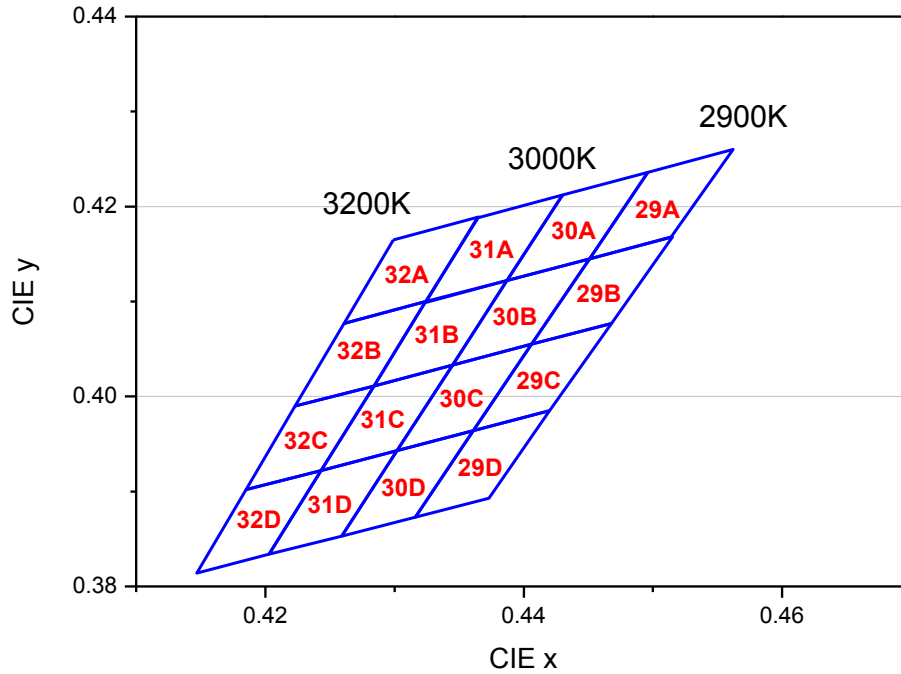

### Color Bin Coordinates

CCT	Bin Code	CIE_x	CIE_y	Bin Code	CIE_x	CIE_y
3000K	29A	0.4496	0.4236	29B	0.4451	0.4145
		0.4451	0.4145		0.4406	0.4055
		0.4514	0.4168		0.4468	0.4077
		0.4562	0.4260		0.4515	0.4168
	29C	0.4406	0.4055	29D	0.4361	0.3964
		0.4361	0.3964		0.4316	0.3873
		0.4420	0.3985		0.4373	0.3893
		0.4468	0.4077		0.4420	0.3985
	30A	0.4430	0.4212	30B	0.4387	0.4122
		0.4387	0.4122		0.4345	0.4033
		0.4451	0.4145		0.4406	0.4055
		0.4496	0.4236		0.4451	0.4145
	30C	0.4345	0.4033	30D	0.4302	0.3943
		0.4302	0.3943		0.4259	0.3853
		0.4361	0.3964		0.4316	0.3873
		0.4406	0.4055		0.4361	0.3964

CCT	Bin Code	CIE_x	CIE_y	Bin Code	CIE_x	CIE_y
3000K	31A	0.4364	0.4188	31B	0.4324	0.4100
		0.4324	0.4099		0.4284	0.4011
		0.4387	0.4122		0.4345	0.4033
		0.4430	0.4212		0.4387	0.4122
	31C	0.4284	0.4011	31D	0.4302	0.3943
		0.4243	0.3922		0.4259	0.3853
		0.4302	0.3943		0.4203	0.3834
		0.4345	0.4033		0.4243	0.3922
	32A	0.4299	0.4165	32B	0.4261	0.4077
		0.4261	0.4077		0.4223	0.3990
		0.4324	0.4100		0.4284	0.4011
		0.4365	0.4189		0.4324	0.4100
	32C	0.4223	0.3990	32D	0.4243	0.3922
		0.4185	0.3902		0.4203	0.3834
		0.4243	0.3922		0.4147	0.3814
		0.4284	0.4011		0.4185	0.3902

### Color Bin Structure

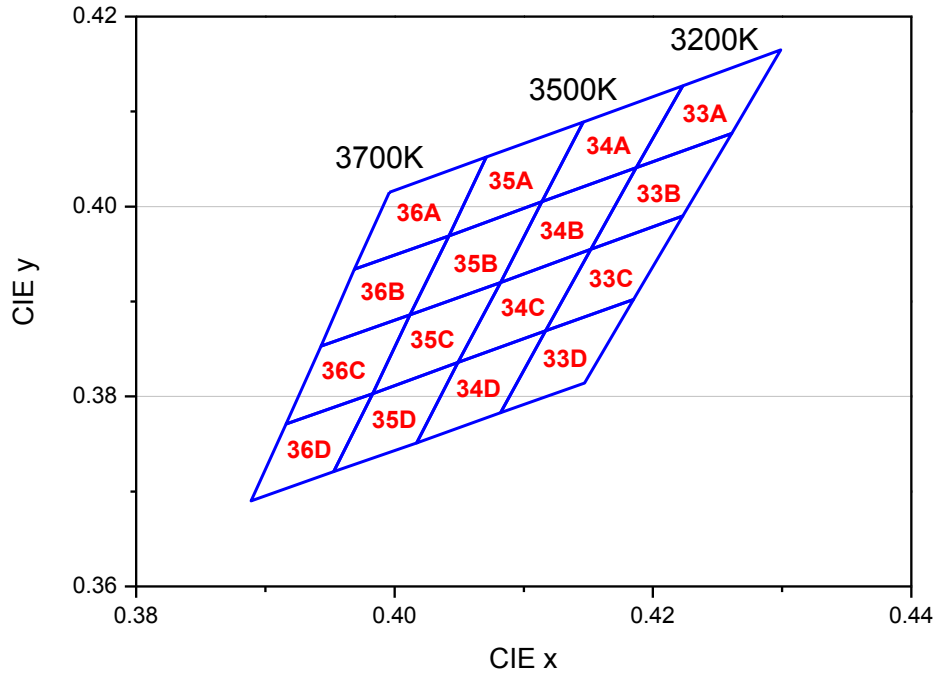

### Color Bin Coordinates

CCT	Bin Code	CIE_x	CIE_y	Bin Code	CIE_x	CIE_y
3500K	33A	0.4223	0.4127	33B	0.4187	0.4041
		0.4187	0.4041		0.4152	0.3955
		0.4261	0.4077		0.4223	0.3990
		0.4299	0.4165		0.4261	0.4077
	33C	0.4152	0.3955	33D	0.4117	0.3869
		0.4117	0.3869		0.4082	0.3783
		0.4185	0.3902		0.4147	0.3814
		0.4223	0.3990		0.4185	0.3902
	34A	0.4146	0.4089	34B	0.4114	0.4005
		0.4114	0.4005		0.4082	0.3920
		0.4187	0.4041		0.4152	0.3955
		0.4223	0.4127		0.4187	0.4041
	34C	0.4082	0.3920	34D	0.4049	0.3836
		0.4049	0.3836		0.4017	0.3751
		0.4117	0.3869		0.4082	0.3783
		0.4152	0.3955		0.4117	0.3869



CCT	Bin Code	CIE_x	CIE_y	Bin Code	CIE_x	CIE_y
3500K	35A	0.4071	0.4052	35B	0.4042	0.3969
		0.4042	0.3969		0.4012	0.3886
		0.4114	0.4005		0.4082	0.3920
		0.4146	0.4089		0.4114	0.4005
	35C	0.4012	0.3886	35D	0.3983	0.3803
		0.3983	0.3803		0.3953	0.3721
		0.4049	0.3836		0.4017	0.3751
		0.4082	0.3920		0.4049	0.3836
	36A	0.3996	0.4015	36B	0.3969	0.3934
		0.3969	0.3934		0.3943	0.3853
		0.4042	0.3969		0.4012	0.3886
		0.4071	0.4052		0.4042	0.3969
	36C	0.3943	0.3853	36D	0.3916	0.3771
		0.3916	0.3771		0.3889	0.3690
		0.3983	0.3803		0.3953	0.3721
		0.4012	0.3886		0.3983	0.3803

**Notes:**

1. Tolerance of Chromaticity Coordinates x,y:  $\pm 0.005$ .

## Forward Voltage Bins

Bin code	Forward Voltage [V]
10	1.00
12	1.25
15	1.50
17	1.75
20	2.00
22	2.25
25	2.50
27	2.75
30	3.00
32	3.25
35	3.50
37	3.75
40	4.00
42	4.25
45	4.50
47	4.75
50	5.00
52	5.25
55	5.50
57	5.75
60	6.00
62	6.25
65	6.50
67	6.75
70	7.00

**Notes:**

1. Forward Voltage measurement tolerance:  $\pm 0.05V$ .
2. Forward Voltage bins are defined at  $I_F = 65mA$  operation.

## 5. Part Number

### 62-117D-W80650H-AM

Part number is designated with below details.

62-117D = Product family name.

W= Color <sup>[1]</sup>

8 = CRI (0=N/A; >70%=7; >80%=8; >90%=9)

065 = Test current [mA]

0 = Lead Frame Type (0=Ag; 1=Au)

H = Brightness Level (H=High; L=Low)

AM = Automotive application

Note

<sup>[1]</sup> Color :

Symbol	Description
C	Cool White
N	Neutral White
W	Warm White
PA	Phosphor Converted Amber
PR	Phosphor Converted Red
UB	Blue
IB	Ice Blue
SB	Sky Blue
UG	Green
UY	Yellow
UA	Amber
UR	Red
SR	Super Red
RGB	RGB-Color

## 6. Ordering Information

**62-117D-W80650H-ABCDEFGHIJLMNOP-QR-AM**

Part Number of the 62-117D	Order Code
62-117D-W80650H-AM	62-117D-W80650H-25A36DB4C52535-2T-AM

Order code contains information with below details :

ABCDEF = min/max wavelength or CCT

GHJL = min./max. Luminous Flux in [lm] or Luminous Intensity in [mcd]

MNOP = min./max. Forward Voltage

QR = internal code

AM = Automotive Application

## 7. Mechanical Dimension

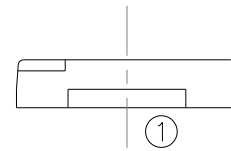
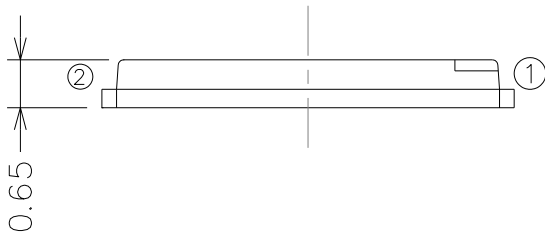
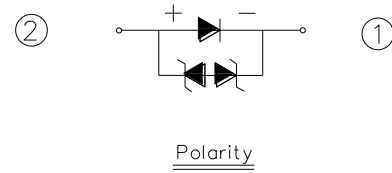
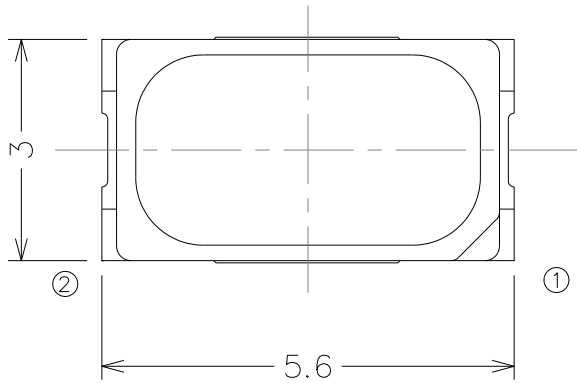

### Notes:

1. Dimensions are in millimeters.
2. Tolerances unless mentioned are  $\pm 0.1\text{mm}$ .

## 8. Recommended Soldering Pad

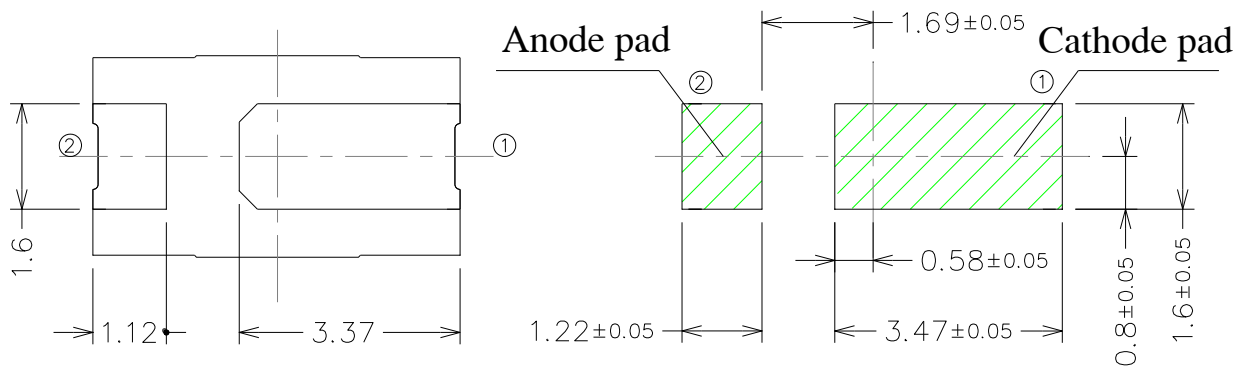

## 9. Reflow Soldering Profile

Soldering Condition (Reference: IPC/JEDEC J-STD-020D)

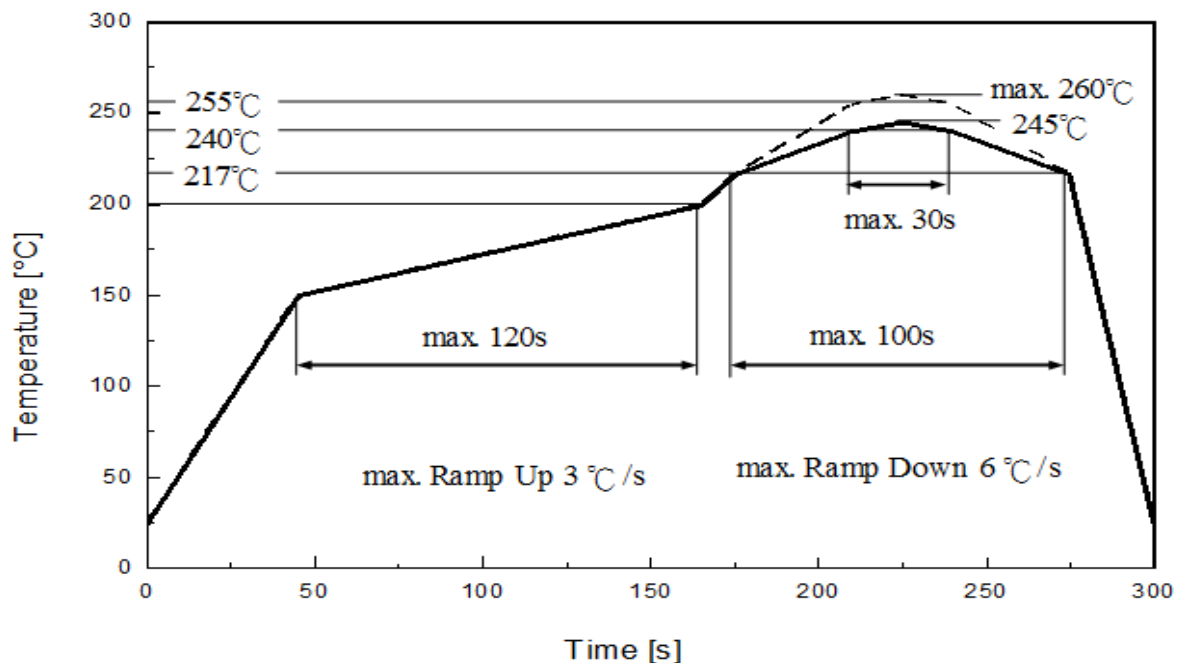

Profile Feature	Pb-Free Assembly	Unit
	Recommendation	
Ramp-up rate to preheat 25 °C to 150 °C	3	°C /sec
Time of soaking zone 150 °C to 200 °C	120	sec
Ramp-up rate to peak	3	°C /sec
Liquefied temperature	217	°C
Time above liquefied temperature	100	sec
Peak temperature (max.)	260	°C
Time within 5°C of the specified peak temperature	30	sec
Ramp-down Rate (max.)	6	°C /sec

## 10. Packaging Information

### • Product Labeling



- CPN : Customer's Product Number
- P/N : Everlight Part Number
- QTY : Packing Quantity
- CAT : Luminous Flux (Brightness) Bin
- HUE : Color Bin
- REF : Forward Voltage Bin
- LOT No : Lot Number

### • Packing: Loaded Quantity 2000 pcs Per Reel

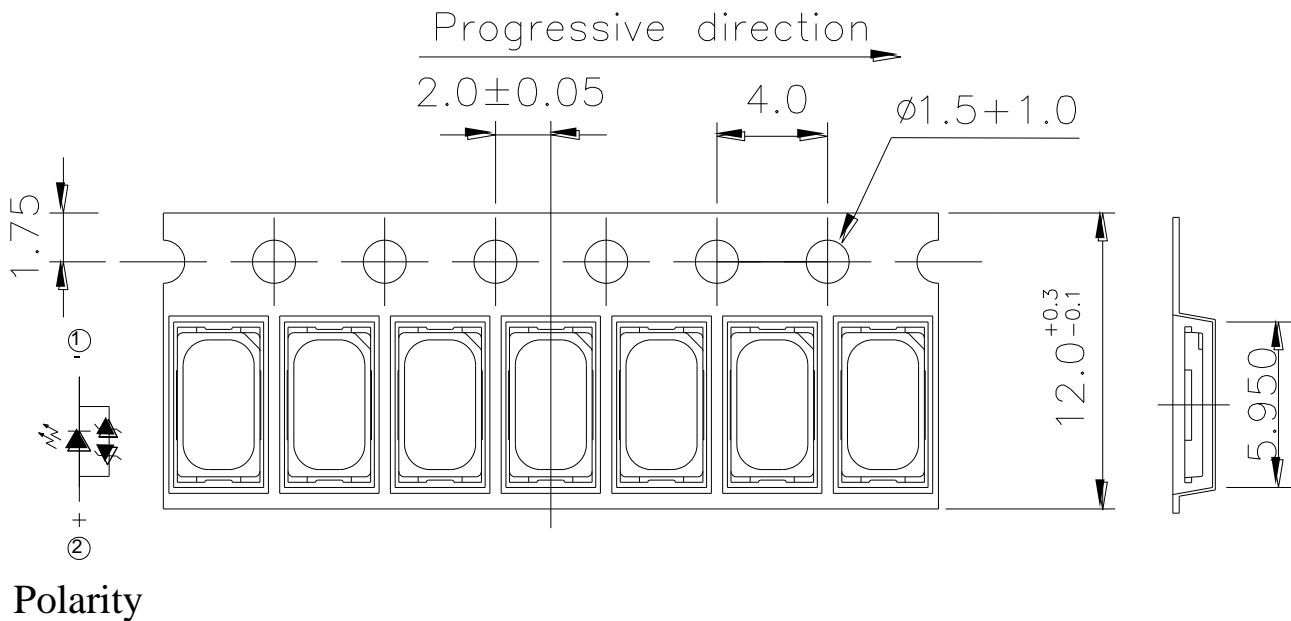

#### Notes:

1. Dimensions are in millimeters.
2. Tolerances for fixed dimensions are ±0.2mm.

### ● Reel Dimensions

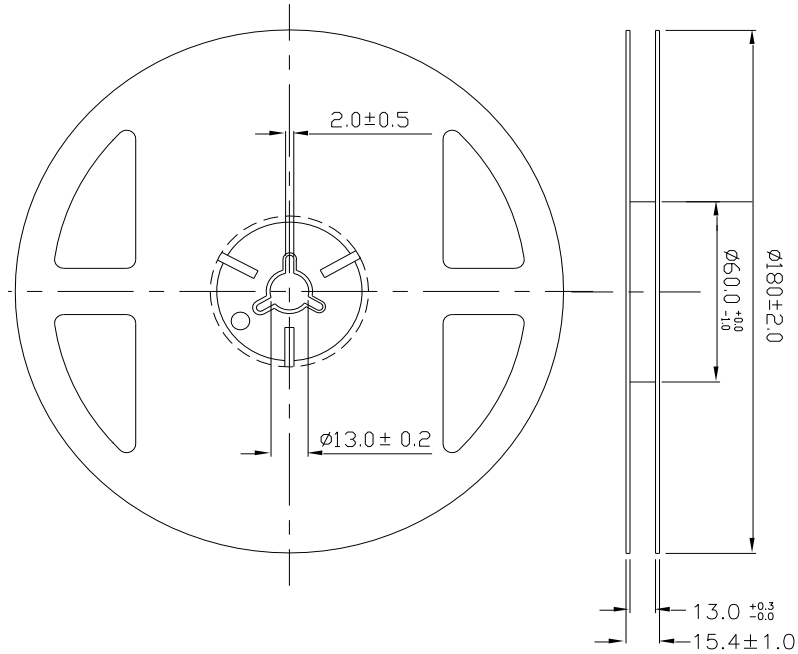

#### Notes:

1. Dimensions are in millimeters.
2. Tolerances unless mentioned are  $\pm 0.2$ mm.

### ● Moisture Resistant Packing Process

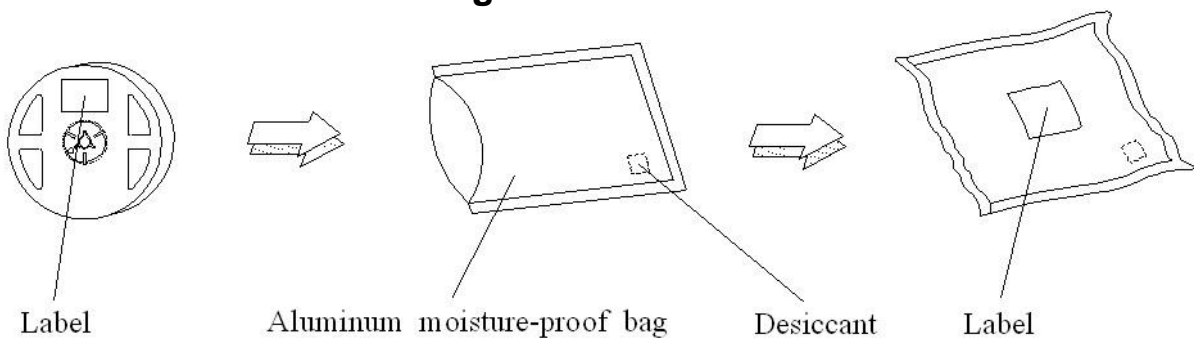

#### Notes:

1. Dimensions are in millimeters.
2. Tolerances unless mentioned are  $\pm 0.2$ mm.



## 11. Precaution for Use

1. Over-current-proof  
Customer must apply resistors for protection; otherwise slight voltage shift will cause big current change (burn out will happen).
2. Assemblies  
Do not stack assemblies containing LEDs to prevent damage to the optical surface of LEDs. Forces applied to the optical surface may result in the surface being damaged.
3. Soldering Condition
  - 3.1 When soldering, do not put stress on the LEDs during heating.
  - 3.2 After soldering, do not warp the circuit board.
4. Soldering Iron  
Each terminal is to go to the tip of soldering iron temperature less than 350°C for 3 seconds within once in less than the soldering iron capacity 25W. Leave two seconds and more intervals, and do soldering of each terminal. Be careful because the damage of the product is often started at the time of the hand solder.
5. Repairing  
Repair should not be done after the LEDs have been soldered. When repairing is unavoidable, a double-head soldering iron should be used (as below figure). It should be confirmed beforehand whether the characteristics of the LEDs will or will not be damaged by repairing.

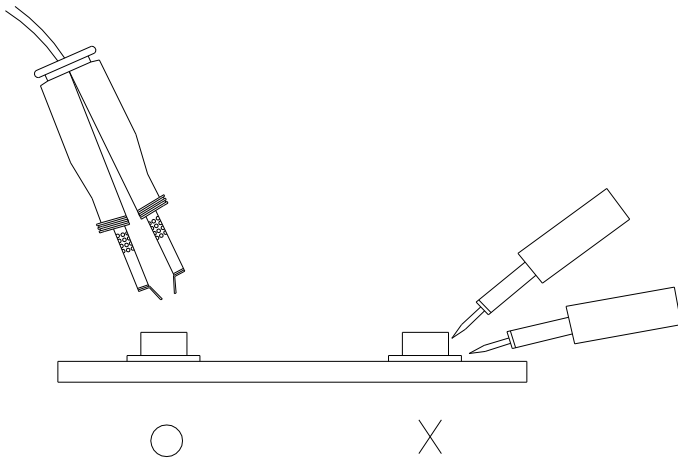

## Revision History

Current version: May.26.2017

Issue No:

Version: 3.0

Created by: Sherry Chen

Rev.	Subjects (major change in previous version)	Modified date
1.0	Standard data sheet	2016/12/13
2.0	Add MSL, surge current, Permissible Pulse Handling Capability fig	2017/05/05
3.0	Modify Chromaticity Coordinates Shift vs. Junction Temperature fig	2017/05/26